

Inversion COB 1.5mm Indoor Small Spacing LED Display Unit

MW7815-FI-CF



Features

- Adopts COB technology, anti-collision and waterproof, IP65(front).
- Adopts flip-chip technology, no wire bonding, stable and reliable, high luminous efficiency, energy efficient.
- Advanced grayscale gives detailed and realistic images.
- Seamlessly splices images without black lines on the screen.
- Modular installation with a magnetic suction tool, simple and stylish appearance, easy installation.
- Supports front maintenance and wall mount.
- Ultra-slim design takes up less space.
- Long lifetime.
- Low heat, excellent heat dissipation, no noise.
- Low failure rate and maintenance cost.

- Ultra-wide viewing angle ensures satisfactory viewing experience from diversified angles.
- High refresh rate and frame frequency provide high image quality without ghosting or smearing.
- Internal connection cable free design.

Specifications

Module	Description
Encapsulation Method	Flip-chip COB common cathode
Pixel Pitch	P1.5
Module Resolution (W*H)	96*108
Module Dimensions (mm)	150*168.75
Cabinet	Description
Cabinet Dimensions (W*H*D) (mm)	600*337.5*39.5
Cabinet Resolution (W*H)	384*216
Processing Image	Description
Single Pixel Brightness Correction	Support
Single Pixel Color Correction	Support
Brightness (nits)	600
Color Temperature (K)	6500 to 12000 adjustable
Viewing Angle (H/V)	170° /160°
Brightness Uniformity	≥97%
Color Uniformity (Cx,Cy)	±0.003Cx,Cy
Contrast Ratio	20000:1
Processing performance	Description
Pixel Density (pitch/m ²)	409600
Surface Evenness (mm)	≤0.1
Grayscale	14bit
Scanning Mode	54S
Drive Mode	Constant current driving
Frame Frequency (Hz)	50/60
Refresh Rate (Hz)	≥3840
Electrical	Description
Power Supply	AC 100 to 240V
Average Power Consumption (W/m ²)	100
Max. Power Consumption (W/m ²)	260
General	Description

Maintenance Mode	Front maintenance
Ingress Protection	IP65
Weight (Kg/pcs)	5
Operation Temperature	-10° C to +40° C
Operating Humidity	10% to 90%RH, non-condensing
Storage Temperature	-20° C to +60° C
Storage Humidity	10% to 90%RH, non-condensing
LED lifetime (h)	100000

Dimensions

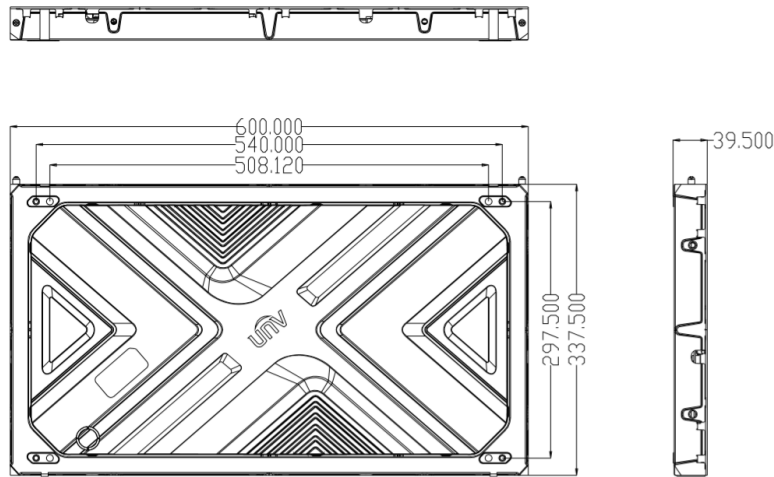

Ordering Info

Product Model	Description
MW7815-FI-CF	Flip-chip COB 1.5mm Indoor Fine Pixel LED Display

Zhejiang Uniview Technologies Co., Ltd.

No. 369, Xietong Road, Xixing Sub-district, Binjiang District, Hangzhou City, 310051, Zhejiang Province, China

Email: overseasbusiness@uniview.com; globalsupport@uniview.com

<http://www.uniview.com>

©2023-2024 Zhejiang Uniview Technologies Co., Ltd. All rights reserved.

*Product specifications and availability are subject to change without notice.

*Despite our best efforts, technical or typographical errors may exist in this document. Uniview cannot be held responsible for any such errors and reserves the right to change the contents of this document without prior notice.